

CARBIDE PUNCHES & DIE INSERTS  
METRIC PRECISION LINE CATALOG



**Oberg Industries**  
PRECISION MANUFACTURING SOLUTIONS

# Oberg Slug Retention

## *Reduce Excessive Manufacturing Costs Associated With Slug Pulling In Your Stamping Operations*

Downtime, broken die components and rejected parts can be extremely costly. Oberg's Slug Retention process can solve those nagging problems by reducing the risk of slugs being pulled to the die surface during withdrawal of the punch.

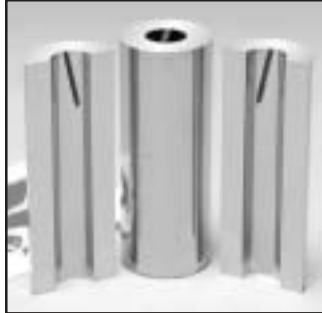

Slug Retention can be used on carbide bushings or die sections with counterbore, tapered or strait I.D. styles, in rounds and most shapes.



### **Our Method Is User Friendly**

Because our process is based on your application, no redesigning of your current tooling is required. This process is very dependable and can be

precisely duplicated each time a component needs to be replaced.

### **Performance Is Guaranteed**

Our Slug Retention method will totally eliminate or greatly reduce your slug pulling difficulties. Test our proven system and receive this guarantee: **Use Oberg Slug Retention and if you are not completely satisfied, we will refund the full cost of the Slug Retention alteration. (This guarantee is limited to only round shapes with inside diameters greater than 0.040").**

### **What It Does**

Oberg Slug Retention is a solution for controlling slugs in carbide die bushings or die sections. This process places an exact amount of trap on the slug to maintain a smooth, even flow of slugs away from the working area of the die. Slug Retention is user friendly and requires no redesigning of your tooling and no special drawings.

### **How It Works**

With our Slug Retention method, a series of carefully calculated interference points are produced on the slug that help to eliminate slug pulling. A precise amount of interference is applied to the blanked slug so that vacuum forces will not pull it back into the work area. The slug expands into a series of special grooves manufactured in the die bushing or die section effectively retaining the slug. These grooves are engineered to prevent the slug from pulling back onto the die face where damage can occur.

### **Features & Benefits**

Eliminates or reduces the following:

- Punch breakage due to double hits
- Use of ejector punches or air holes
- Slug marks on parts
- Press downtime
- Wasted material
- Die maintenance
- New die development

### **How to Order**

Just send us your print via mail, fax or e-mail and include the following information:

- Material type
- Material thickness
- Material hardness
- Break clearance per side

## Carbide Punches with Machinable Steel Sleeve Type Head

These punches are recommended for medium to heavy punching requirements. They will out-perform steel punches many times, and they perform best when used in good quality dies.

The length of the steel sleeve (head thickness "T") is standard at 5mm or 13mm, but may be ordered at any specified dimension less than 13mm.

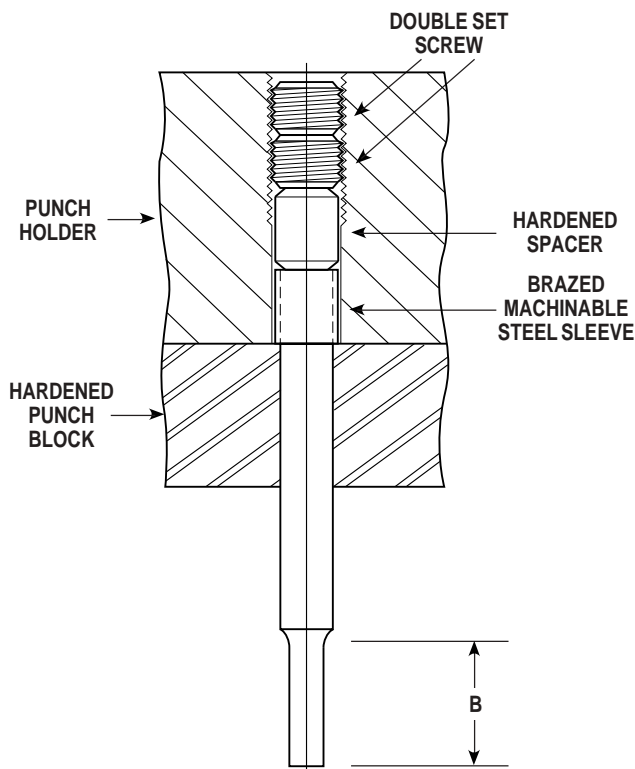

In the sectional view above, please note that:

1. Double set screws are recommended.
2. The hardened spacer next to the punch head is optional, and may be omitted.
3. By turning or grinding the shoulder of the soft steel head, the effective body length of the punch may be increased.
4. In most sizes, the length of the punch tip "B" may be renewed or increased by sending to OCP&D for regrinding, or by regrinding in your own shop.

## Carbide Punches with Carbide Head and Hardened Steel Collar

These punches are for the stamper who prefers one piece carbide punches with carbide heads. They will out-perform steel punches many times when used in good quality dies.

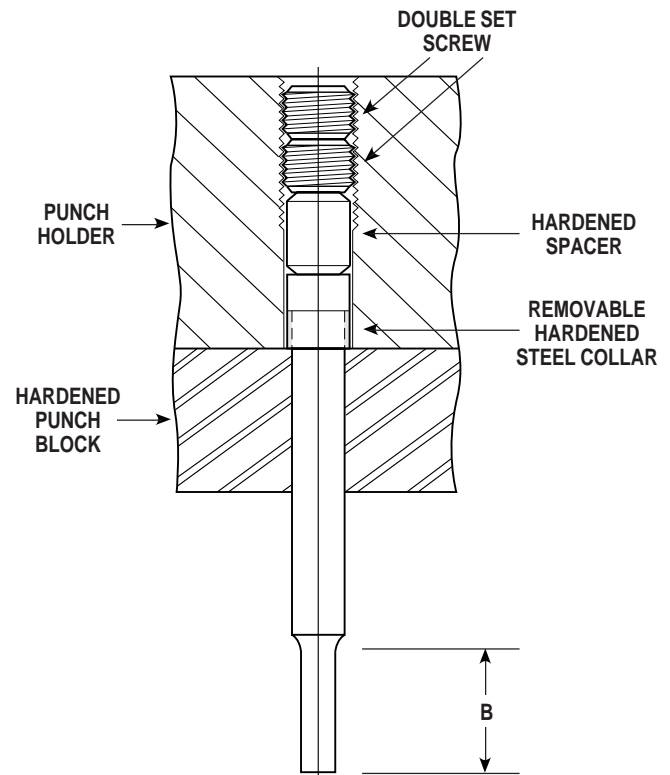









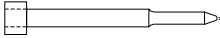

In the sectional view above, please note that:

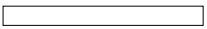
1. Double set screws are recommended.
2. The hardened spacer is optional, and may be omitted.
3. To facilitate adjustment, each punch is supplied with a hardened steel collar which may be removed and ground off.
4. In most sizes, the length of the punch tip "B" may be renewed or increased by sending to OCP&D for regrinding, or by regrinding in your own shop.

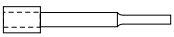
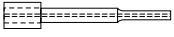
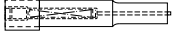
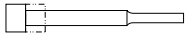
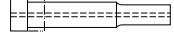
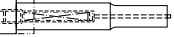
# CONTENTS

**METRIC**

Page

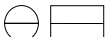
|   |   |    |
|---|---|----|
| • Carbide Pilots with Machinable Steel Sleeve Head  |    | 5  |
| • Carbide Pilots with Steel Pilot Body  |    | 5  |
| • Carbide Round Blanks  |    | 6  |
| • Carbide Punches, Straight Ground with   |    | 7  |
| • Carbide Punches with Machinable Steel Sleeve Head                                       |    | 8  |
| • Carbide Punches with Air Hole and Machinable Steel Sleeve Head                          |    | 9  |
| • Carbide Punches with Self-Contained Ejector Pin and Machinable Steel Sleeve Head        |    | 10 |
| • Carbide Punches with Carbide Head and Hardened Steel Collar                             |    | 11 |
| • Carbide Punches with Air Hole, Carbide Head and Hardened Steel Collar                   |  | 12 |
| • Carbide Punches with Self-Contained Ejector Pin, Carbide Head and Hardened Steel Collar |  | 13 |
| • Carbide Die Inserts with Full Length Taper  |  | 14 |
| • Carbide Die Inserts with Full Length Taper and Machinable Steel Sleeve Head             |  | 15 |
| • Carbide Die Inserts with Counterbore  |  | 16 |
| • Carbide Die Inserts with Counterbore and Machinable Steel Sleeve Head                   |  | 17 |
| • Carbide Die Inserts, Wire EDM Blanks With Starter Hole                                  |  | 18 |
| • Carbide Die Inserts, Half Rounds  |  | 19 |
| • Special Shapes  |   | 20 |
| • Locating Devices  |   | 21 |



# Carbide Pilots with Machinable Steel Sleeve Head

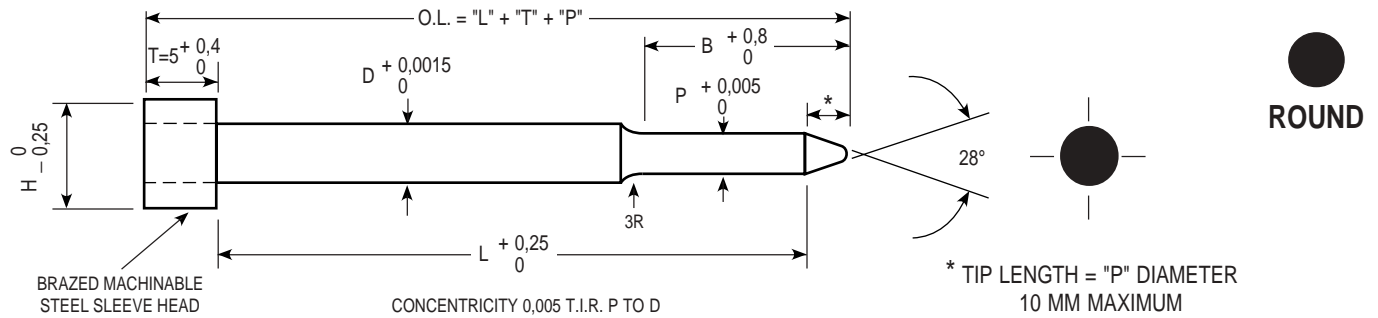

| CATALOG NUMBER | D BODY DIAMETER | P POINT DIAMETER | B POINT LENGTH | H HEAD DIAMETER | L = LENGTH UNDER HEAD |    |    |    |    |    |
|----------------|-----------------|------------------|----------------|-----------------|-----------------------|----|----|----|----|----|
|                |                 |                  |                |                 | 40                    | 50 | 60 | 70 | 80 | 90 |
| 1PNS-5M        | 5,0             | 1,50 - 5,00      | 20             | 8,00            | •                     | •  | •  | •  | •  | •  |
| 1PNS-6M        | 6,0             | 1,50 - 5,00      | 20             | 9,00            | •                     | •  | •  | •  | •  | •  |
| 2PNS-6M        | 6,0             | 5,01 - 6,00      | 25             | 9,00            | •                     | •  | •  | •  | •  | •  |
| 1PNS-8M        | 8,0             | 4,00 - 8,00      | 25             | 11,00           | •                     | •  | •  | •  | •  | •  |
| 1PNS-10M       | 10,0            | 5,00 - 10,00     | 25             | 13,00           | •                     | •  | •  | •  | •  | •  |
| 1PNS-13M       | 13,0            | 10,00 - 13,00    | 25             | 16,00           | •                     | •  | •  | •  | •  | •  |
| 1PNS-16M       | 16,0            | 10,00 - 16,00    | 25             | 19,00           | •                     | •  | •  | •  | •  | •  |



NOTE: ANY DIMENSION OTHER THAN THOSE SHOWN QUOTED ON REQUEST

WHEN ORDERING SPECIFY:

| Quantity | Catalog Number | L    | P     |
|----------|----------------|------|-------|
| 7        | 1PNS-8M        | 60,0 | 7,625 |

# Carbide Pilots with Steel Pilot Body

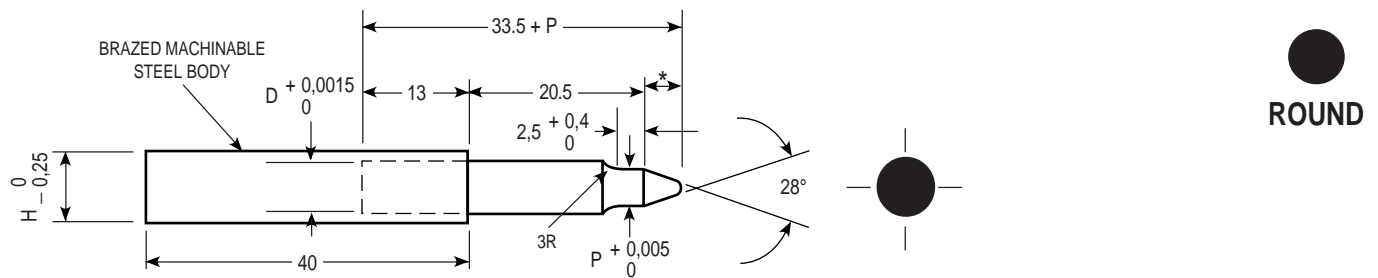

| CATALOG NUMBER | H STEEL BODY DIAMETER | D CARBIDE DIAMETER | P POINT DIAMETER |
|----------------|-----------------------|--------------------|------------------|
| 1PNSP-5M       | 8,00                  | 5,0                | 1,50 - 5,00      |
| 1PNSP-6M       | 9,00                  | 6,0                | 1,50 - 6,00      |
| 1PNSP-8M       | 11,00                 | 8,0                | 3,00 - 8,00      |
| 1PNSP-10M      | 13,00                 | 10,0               | 7,50 - 10,00     |

\* TIP LENGTH = "P" DIAMETER 10 MM MAXIMUM

WHEN ORDERING SPECIFY:

| Quantity | Catalog Number | P    |
|----------|----------------|------|
| 6        | 1PNSP-8M       | 4,13 |



Any dimension other than those shown are available. Please ask for a special quotation.

# Carbide Round Blanks Precision Ground

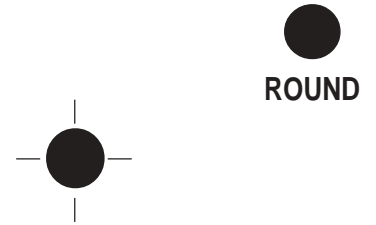
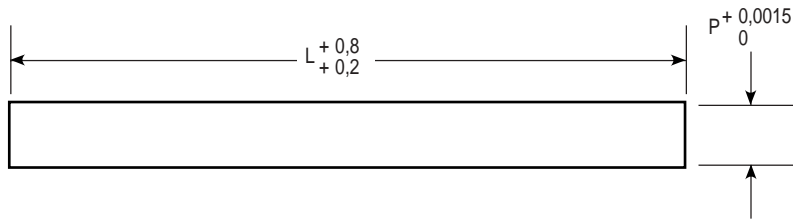

| CATALOG NUMBER | P POINT DIAMETER | L = LENGTH |    |    |    |    |     |
|----------------|------------------|------------|----|----|----|----|-----|
|                |                  | 50         | 60 | 70 | 80 | 90 | 100 |
| 1PR-2M         | 2,00             | •          | •  | •  | •  | •  | •   |
| 1PR-3M         | 3,00             | •          | •  | •  | •  | •  | •   |
| 1PR-4M         | 4,00             | •          | •  | •  | •  | •  | •   |
| 1PR-5M         | 5,00             | •          | •  | •  | •  | •  | •   |
| 1PR-6M         | 6,00             | •          | •  | •  | •  | •  | •   |
| 1PR-8M         | 8,00             | •          | •  | •  | •  | •  | •   |
| 1PR-10M        | 10,00            | •          | •  | •  | •  | •  | •   |
| 1PR-13M        | 13,00            | •          | •  | •  | •  | •  | •   |
| 1PR-16M        | 16,00            | •          | •  | •  | •  | •  | •   |
| 1PR-20M        | 20,00            | •          | •  | •  | •  | •  | •   |
| 1PR-25M        | 25,00            | •          | •  | •  | •  | •  | •   |



NOTE: ANY DIMENSION OTHER THAN THOSE SHOWN QUOTED ON REQUEST

WHEN ORDERING SPECIFY:

| Quantity | Catalog Number | L  |
|----------|----------------|----|
| 12       | 1PR-8M         | 70 |

# Carbide Round Blanks Precision Ground

| CATALOG NUMBER | P + 0,005 / 0 DIAMETER | L = LENGTH + 0,8 / + 0,2          |
|----------------|------------------------|-----------------------------------|
| 1SCR-M         | 0,15 - 0,74            | AVAILABLE IN LENGTHS UP TO 150 MM |

| CATALOG NUMBER | P + 0,0015 / 0 DIAMETER | L = LENGTH + 0,8 / + 0,2          |
|----------------|-------------------------|-----------------------------------|
| 2SCR-M         | 0,75 - 9,00             | AVAILABLE IN LENGTHS UP TO 150 MM |

NOTE: ANY DIMENSION OTHER THAN THOSE SHOWN QUOTED ON REQUEST

WHEN ORDERING SPECIFY:

| Quantity | Catalog Number | L   | P    |
|----------|----------------|-----|------|
| 10       | 2SCR-M         | 150 | 1,32 |

# Carbide Punches, Straight Ground with Machinable Steel Sleeve Head

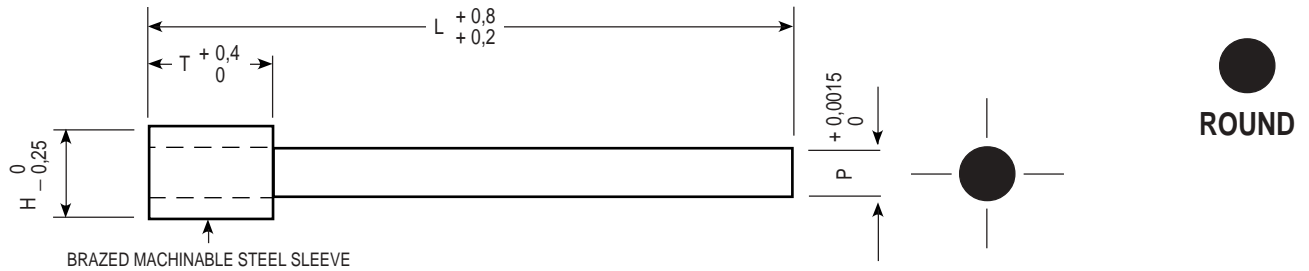

| CATALOG NUMBER | P POINT DIAMETER | H HEAD DIAMETER | T HEAD LENGTH | L = LENGTH |    |    |    |    |     |
|----------------|------------------|-----------------|---------------|------------|----|----|----|----|-----|
|                |                  |                 |               | 50         | 60 | 70 | 80 | 90 | 100 |
| 1PQ-M          | 1,000 - 1,499    | 3,00            | 5             | .          | .  | .  | .  | .  | .   |
| 2PQ-M          | 1,500 - 1,999    | 3,00            | 5             | .          | .  | .  | .  | .  | .   |
| 3PQ-M          | 2,000            | 3,00            | 5             | .          | .  | .  | .  | .  | .   |
| 4PQ-M          | 2,001 - 2,500    | 5,00            | 5             | .          | .  | .  | .  | .  | .   |
| 5PQ-M          | 2,501 - 2,999    | 5,00            | 5             | .          | .  | .  | .  | .  | .   |
| 6PQ-M          | 3,000            | 5,00            | 5             | .          | .  | .  | .  | .  | .   |
| 7PQ-M          | 3,001 - 3,500    | 6,00            | 5             | .          | .  | .  | .  | .  | .   |
| 8PQ-M          | 3,501 - 3,999    | 6,00            | 5             | .          | .  | .  | .  | .  | .   |
| 9PQ-M          | 4,000            | 7,00            | 5             | .          | .  | .  | .  | .  | .   |
| 10PQ-M         | 4,001 - 4,500    | 7,00            | 13            | .          | .  | .  | .  | .  | .   |
| 11PQ-M         | 4,501 - 4,999    | 7,00            | 13            | .          | .  | .  | .  | .  | .   |
| 12PQ-M         | 5,000            | 8,00            | 13            | .          | .  | .  | .  | .  | .   |
| 13PQ-M         | 5,001 - 5,500    | 8,00            | 13            | .          | .  | .  | .  | .  | .   |
| 14PQ-M         | 5,501 - 5,999    | 8,00            | 13            | .          | .  | .  | .  | .  | .   |
| 15PQ-M         | 6,000            | 9,00            | 13            | .          | .  | .  | .  | .  | .   |
| 16PQ-M         | 6,001 - 6,999    | 9,00            | 13            | .          | .  | .  | .  | .  | .   |
| 17PQ-M         | 7,000 - 7,999    | 10,00           | 13            | .          | .  | .  | .  | .  | .   |
| 18PQ-M         | 8,000            | 11,00           | 13            | .          | .  | .  | .  | .  | .   |
| 19PQ-M         | 8,001 - 8,999    | 11,00           | 13            | .          | .  | .  | .  | .  | .   |
| 20PQ-M         | 9,000 - 9,999    | 12,00           | 13            | .          | .  | .  | .  | .  | .   |
| 21PQ-M         | 10,000           | 13,00           | 13            | .          | .  | .  | .  | .  | .   |
| 22PQ-M         | 13,000           | 16,00           | 13            | .          | .  | .  | .  | .  | .   |
| 23PQ-M         | 16,000           | 19,00           | 13            | .          | .  | .  | .  | .  | .   |
| 24PQ-M         | 20,000           | 23,00           | 13            | .          | .  | .  | .  | .  | .   |
| 25PQ-M         | 25,000           | 28,00           | 13            | .          | .  | .  | .  | .  | .   |



**AVAILABLE ON REQUEST - BRAZED MACHINABLE STEEL SLEEVE HEAD**

**CATALOG NUMBER**  
**PQB-M**

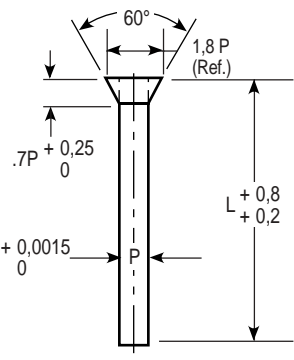

NOTE: ANY DIMENSION OTHER THAN THOSE SHOWN QUOTED ON REQUEST

**WHEN ORDERING SPECIFY:**

| Quantity | Catalog Number | L  | P    |
|----------|----------------|----|------|
| 3        | 4PQ-M          | 80 | 2,50 |



# Carbide Punches with Machinable Steel Sleeve Head

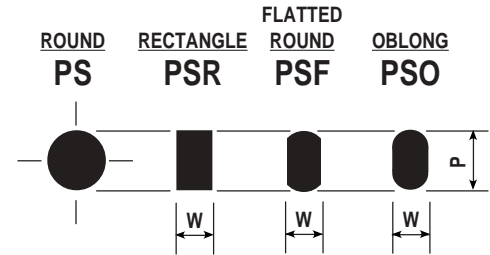
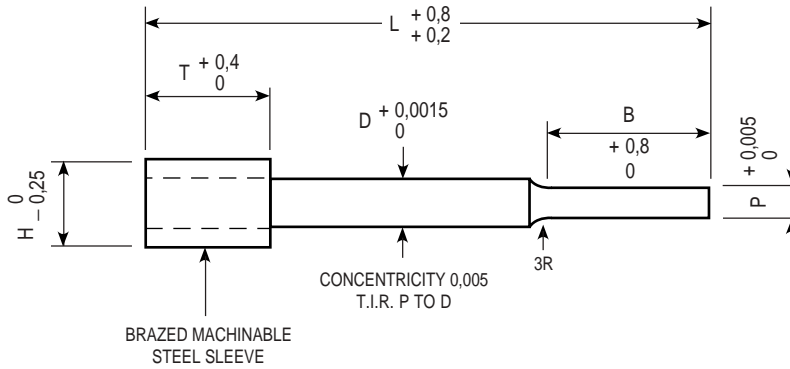

| CATALOG NUMBER | D DIAMETER | P POINT DIAMETER | B POINT LENGTH | H HEAD DIAMETER | T HEAD LENGTH | L = LENGTH |    |    |    |    |     |
|----------------|------------|------------------|----------------|-----------------|---------------|------------|----|----|----|----|-----|
|                |            |                  |                |                 |               | 50         | 60 | 70 | 80 | 90 | 100 |
| 1PS-3M         | 3,0        | 0,75 - 1,50      | 8              | 5,00            | 5             | •          | •  | •  | •  | •  | •   |
| 2PS-3M         | 3,0        | 1,51 - 3,00      | 20             | 5,00            | 5             | •          | •  | •  | •  | •  | •   |
| 1PS-4M         | 4,0        | 0,75 - 1,50      | 8              | 7,00            | 5             | •          | •  | •  | •  | •  | •   |
| 2PS-4M         | 4,0        | 1,51 - 4,00      | 20             | 7,00            | 5             | •          | •  | •  | •  | •  | •   |
| 1PS-5M         | 5,0        | 0,75 - 1,50      | 8              | 8,00            | 13            | •          | •  | •  | •  | •  | •   |
| 2PS-5M         | 5,0        | 1,51 - 5,00      | 20             | 8,00            | 13            | •          | •  | •  | •  | •  | •   |
| 1PS-6M         | 6,0        | 1,50 - 5,00      | 20             | 9,00            | 13            | •          | •  | •  | •  | •  | •   |
| 2PS-6M         | 6,0        | 5,01 - 6,00      | 22             | 9,00            | 13            | •          | •  | •  | •  | •  | •   |
| 1PS-8M         | 8,0        | 3,00 - 8,00      | 22             | 11,00           | 13            | •          | •  | •  | •  | •  | •   |
| 1PS-10M        | 10,0       | 7,00 - 10,00     | 22             | 13,00           | 13            | •          | •  | •  | •  | •  | •   |
| 1PS-13M        | 13,0       | 10,00 - 13,00    | 22             | 16,00           | 13            | •          | •  | •  | •  | •  | •   |
| 1PS-16M        | 16,0       | 11,00 - 16,00    | 22             | 19,00           | 13            | •          | •  | •  | •  | •  | •   |
| 1PS-20M        | 20,0       | 15,00 - 20,00    | 22             | 23,00           | 13            | •          | •  | •  | •  | •  | •   |

All outside corners to be sharp unless otherwise specified by customer.



NOTE: ANY DIMENSION OTHER THAN THOSE SHOWN QUOTED ON REQUEST

**WHEN ORDERING SPECIFY:**

| Quantity | Catalog Number | L  | P    |
|----------|----------------|----|------|
| 5        | 1PS-8M         | 90 | 7,23 |

| Quantity | Catalog Number | L  | Point Dimensions     |
|----------|----------------|----|----------------------|
| 16       | 1PSR-6M        | 60 | W = 2,12<br>P = 3,06 |

# Carbide Punches with Air Hole and Machinable Steel Sleeve Head

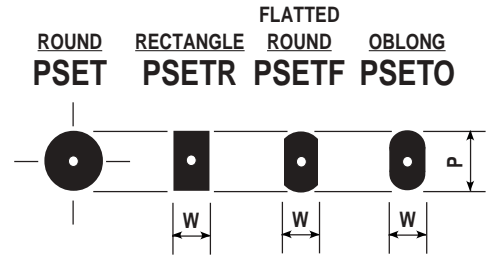
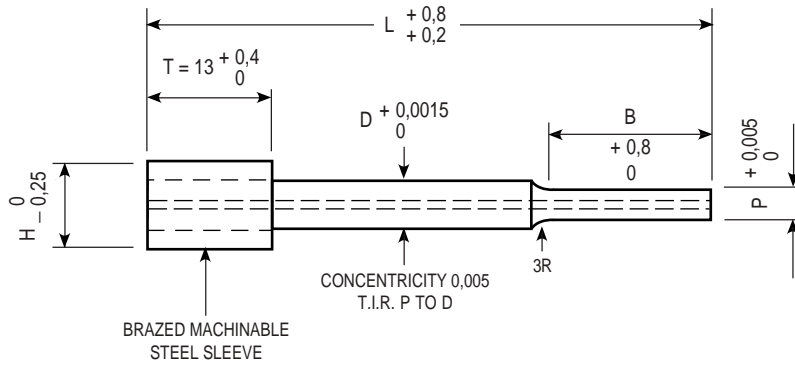

| CATALOG NUMBER | D DIAMETER | P POINT DIAMETER | B POINT LENGTH | H HEAD DIAMETER | L = LENGTH    |    |    |    |    |    |     |
|----------------|------------|------------------|----------------|-----------------|---------------|----|----|----|----|----|-----|
|                |            |                  |                |                 | AIR HOLE DIA. | 50 | 60 | 70 | 80 | 90 | 100 |
| 1PSET-5M       | 5,0        | 2,50 - 5,00      | 20             | 8,00            | 1,2           | •  | •  | •  | •  | •  | •   |
| 1PSET-6M       | 6,0        | 2,50 - 6,00      | 20             | 9,00            | 1,2           | •  | •  | •  | •  | •  | •   |
| 1PSET-8M       | 8,0        | 4,00 - 8,00      | 22             | 11,00           | 1,2           | •  | •  | •  | •  | •  | •   |
| 1PSET-10M      | 10,0       | 7,00 - 10,00     | 22             | 13,00           | 2,8           | •  | •  | •  | •  | •  | •   |
| 1PSET-13M      | 13,0       | 10,00 - 13,00    | 22             | 16,00           | 3,6           | •  | •  | •  | •  | •  | •   |
| 1PSET-16M      | 16,0       | 11,00 - 16,00    | 22             | 19,00           | 3,6           | •  | •  | •  | •  | •  | •   |
| 1PSET-20M      | 20,0       | 15,00 - 20,00    | 22             | 23,00           | 3,6           | •  | •  | •  | •  | •  | •   |

NOTE: ANY DIMENSION OTHER THAN THOSE SHOWN QUOTED ON REQUEST

All outside corners to be sharp unless otherwise specified by customer.



**WHEN ORDERING SPECIFY:**

| Quantity | Catalog Number | L  | P    |
|----------|----------------|----|------|
| 5        | 1PSET-5M       | 50 | 4,23 |

| Quantity | Catalog Number | L  | Point Dimensions     |
|----------|----------------|----|----------------------|
| 12       | 1PSETO-5M      | 50 | W = 3,23<br>P = 4,23 |

# Carbide Punches with Self-Contained Ejector Pin and Machinable Steel Sleeve Head

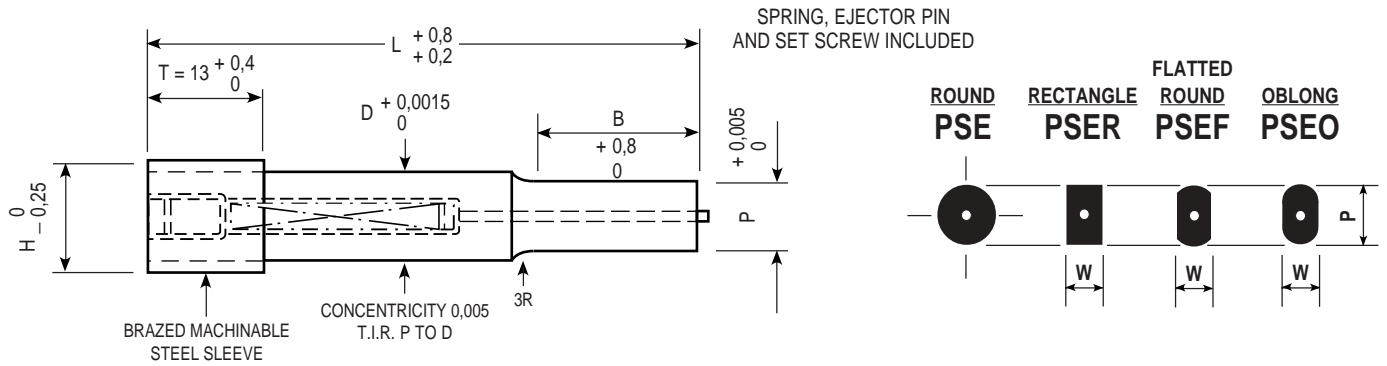

| CATALOG NUMBER | D DIAMETER | P POINT DIAMETER | B POINT LENGTH | H HEAD DIAMETER | L = LENGTH |    |    |    |    |     |
|----------------|------------|------------------|----------------|-----------------|------------|----|----|----|----|-----|
|                |            |                  |                |                 | 50         | 60 | 70 | 80 | 90 | 100 |
| 1PSE-5M        | 5,0        | 2,50 - 5,00      | 20             | 8,00            | •          | •  | •  | •  | •  | •   |
| 1PSE-6M        | 6,0        | 2,50 - 6,00      | 20             | 9,00            | •          | •  | •  | •  | •  | •   |
| 1PSE-8M        | 8,0        | 4,00 - 8,00      | 22             | 11,00           | •          | •  | •  | •  | •  | •   |
| 1PSE-10M       | 10,0       | 7,00 - 10,00     | 22             | 13,00           | •          | •  | •  | •  | •  | •   |
| 1PSE-13M       | 13,0       | 10,00 - 13,00    | 22             | 16,00           | •          | •  | •  | •  | •  | •   |
| 1PSE-16M       | 16,0       | 11,00 - 16,00    | 22             | 19,00           | •          | •  | •  | •  | •  | •   |
| 1PSE-20M       | 20,0       | 15,00 - 20,00    | 22             | 23,00           | •          | •  | •  | •  | •  | •   |

NOTE: ANY DIMENSION OTHER THAN THOSE SHOWN QUOTED ON REQUEST

All outside corners to be sharp unless otherwise specified by customer.



**WHEN ORDERING SPECIFY:**

| Quantity | Catalog Number | L  | P     |
|----------|----------------|----|-------|
| 5        | 1PSE-13M       | 90 | 10,12 |

| Quantity | Catalog Number | L  | Point Dimensions     |
|----------|----------------|----|----------------------|
| 12       | 1PSER-13M      | 90 | W = 6,00<br>P = 7,00 |

# Carbide Punches with Carbide Head and Hardened Steel Collar

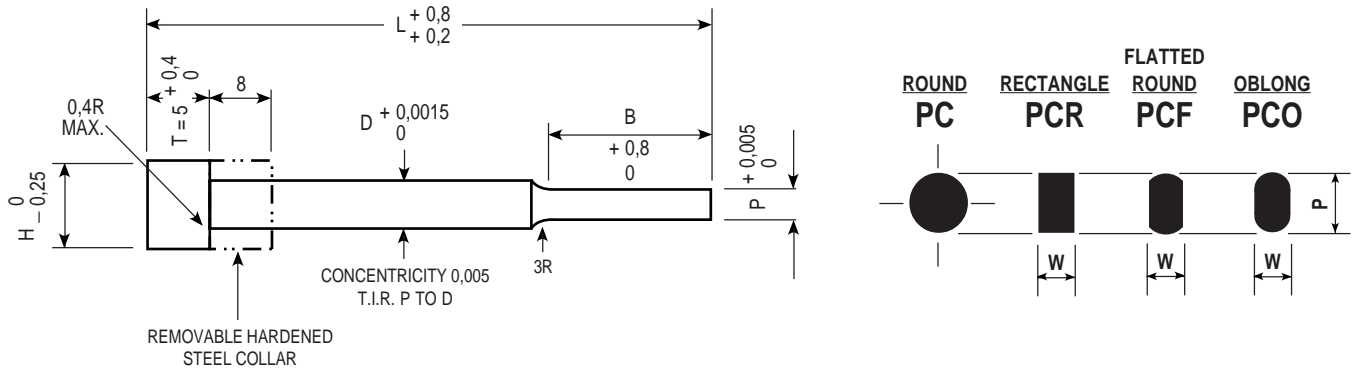

| CATALOG NUMBER | D BODY DIAMETER | P POINT DIAMETER | B POINT LENGTH | H HEAD DIAMETER | L = LENGTH |    |    |    |    |     |
|----------------|-----------------|------------------|----------------|-----------------|------------|----|----|----|----|-----|
|                |                 |                  |                |                 | 50         | 60 | 70 | 80 | 90 | 100 |
| 1PC-4M         | 4,0             | 0,75 - 1,50      | 8              | 7,00            | •          | •  | •  | •  | •  | •   |
| 2PC-4M         | 4,0             | 1,51 - 4,00      | 20             | 7,00            | •          | •  | •  | •  | •  | •   |
| 1PC-5M         | 5,0             | 0,75 - 1,50      | 8              | 8,00            | •          | •  | •  | •  | •  | •   |
| 2PC-5M         | 5,0             | 1,51 - 5,00      | 20             | 8,00            | •          | •  | •  | •  | •  | •   |
| 1PC-6M         | 6,0             | 1,50 - 5,00      | 20             | 9,00            | •          | •  | •  | •  | •  | •   |
| 2PC-6M         | 6,0             | 5,01 - 6,00      | 22             | 9,00            | •          | •  | •  | •  | •  | •   |
| 1PC-8M         | 8,0             | 3,00 - 8,00      | 22             | 11,00           | •          | •  | •  | •  | •  | •   |
| 1PC-10M        | 10,0            | 7,00 - 10,00     | 22             | 13,00           | •          | •  | •  | •  | •  | •   |
| 1PC-13M        | 13,0            | 10,00 - 13,00    | 22             | 16,00           | •          | •  | •  | •  | •  | •   |
| 1PC-16M        | 16,0            | 11,00 - 16,00    | 22             | 19,00           | •          | •  | •  | •  | •  | •   |
| 1PC-20M        | 20,0            | 15,00 - 20,00    | 22             | 23,00           | •          | •  | •  | •  | •  | •   |

NOTE: ANY DIMENSION OTHER THAN THOSE SHOWN QUOTED ON REQUEST

All outside corners to be sharp unless otherwise specified by customer.



**WHEN ORDERING SPECIFY:**

| Quantity | Catalog Number | L   | P    |
|----------|----------------|-----|------|
| 5        | 2PC-6M         | 100 | 5,50 |

| Quantity | Catalog Number | L   | Point Dimensions     |
|----------|----------------|-----|----------------------|
| 12       | 2PCF-6M        | 100 | W = 4,50<br>P = 5,50 |

# Carbide Punches with Air Hole, Carbide Head and Hardened Steel Collar

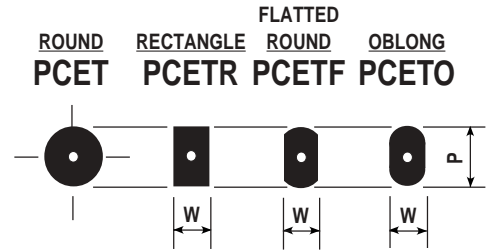
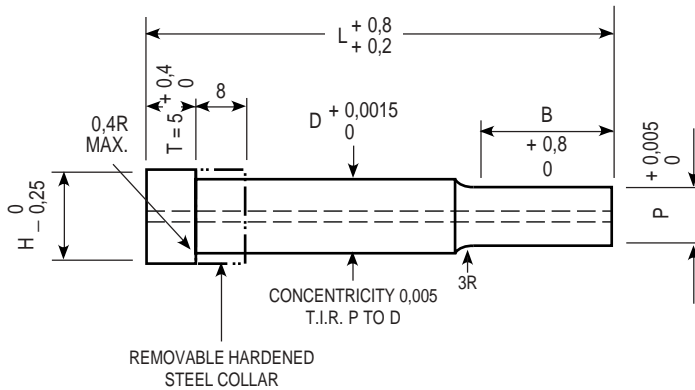

| CATALOG NUMBER | D BODY DIAMETER | P POINT DIAMETER | B POINT LENGTH | H HEAD DIAMETER | L = LENGTH    |    |    |    |    |    |     |
|----------------|-----------------|------------------|----------------|-----------------|---------------|----|----|----|----|----|-----|
|                |                 |                  |                |                 | AIR HOLE DIA. | 50 | 60 | 70 | 80 | 90 | 100 |
| 1PCET-5M       | 5,0             | 2,50 - 5,00      | 20             | 8,00            | 1,2           | •  | •  | •  | •  | •  | •   |
| 1PCET-6M       | 6,0             | 2,50 - 6,00      | 20             | 9,00            | 1,2           | •  | •  | •  | •  | •  | •   |
| 1PCET-8M       | 8,0             | 4,00 - 8,00      | 22             | 11,00           | 1,2           | •  | •  | •  | •  | •  | •   |
| 1PCET-10M      | 10,0            | 7,00 - 10,00     | 22             | 13,00           | 2,8           | •  | •  | •  | •  | •  | •   |
| 1PCET-13M      | 13,0            | 10,00 - 13,00    | 22             | 16,00           | 3,6           | •  | •  | •  | •  | •  | •   |
| 1PCET-16M      | 16,0            | 11,00 - 16,00    | 22             | 19,00           | 3,6           | •  | •  | •  | •  | •  | •   |
| 1PCET-20M      | 20,0            | 15,00 - 20,00    | 22             | 23,00           | 3,6           | •  | •  | •  | •  | •  | •   |

All outside corners to be sharp unless otherwise specified by customer.

NOTE: ANY DIMENSION OTHER THAN THOSE SHOWN QUOTED ON REQUEST



**WHEN ORDERING SPECIFY:**

| Quantity | Catalog Number | L  | P    |
|----------|----------------|----|------|
| 5        | 1PCET-8M       | 60 | 5,50 |

| Quantity | Catalog Number | L  | Point Dimensions     |
|----------|----------------|----|----------------------|
| 12       | 1PCETR-8M      | 60 | W = 4,50<br>P = 5,50 |

# Carbide Punches with Self-Contained Ejector Pin, Carbide Head and Hardened Steel Collar

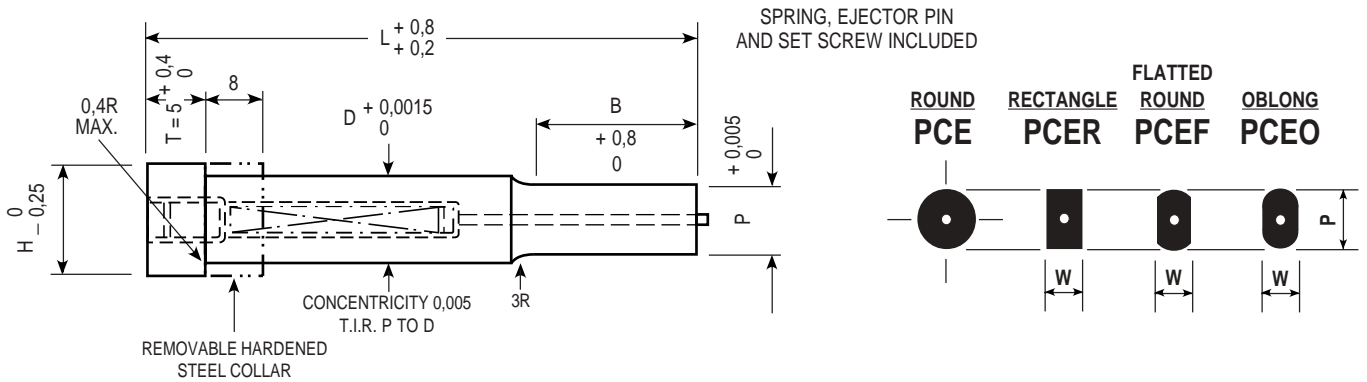

| CATALOG NUMBER | D BODY DIAMETER | P POINT DIAMETER | B POINT LENGTH | H HEAD DIAMETER | L = LENGTH |    |    |    |    |     |
|----------------|-----------------|------------------|----------------|-----------------|------------|----|----|----|----|-----|
|                |                 |                  |                |                 | 50         | 60 | 70 | 80 | 90 | 100 |
| 1PCE-5M        | 5,0             | 2,50 - 5,00      | 20             | 8,00            | •          | •  | •  | •  | •  | •   |
| 1PCE-6M        | 6,0             | 2,50 - 6,00      | 20             | 9,00            | •          | •  | •  | •  | •  | •   |
| 1PCE-8M        | 8,0             | 4,00 - 8,00      | 22             | 11,00           | •          | •  | •  | •  | •  | •   |
| 1PCE-10M       | 10,0            | 7,00 - 10,00     | 22             | 13,00           | •          | •  | •  | •  | •  | •   |
| 1PCE-13M       | 13,0            | 10,00 - 13,00    | 22             | 16,00           | •          | •  | •  | •  | •  | •   |
| 1PCE-16M       | 16,0            | 11,00 - 16,00    | 22             | 19,00           | •          | •  | •  | •  | •  | •   |
| 1PCE-20M       | 20,0            | 15,00 - 20,00    | 22             | 23,00           | •          | •  | •  | •  | •  | •   |

All outside corners to be sharp unless otherwise specified by customer.

NOTE: ANY DIMENSION OTHER THAN THOSE SHOWN QUOTED ON REQUEST



**WHEN ORDERING SPECIFY:**

| Quantity | Catalog Number | L  | P    |
|----------|----------------|----|------|
| 5        | 1PCE-8M        | 80 | 6,92 |

| Quantity | Catalog Number | L  | Point Dimensions     |
|----------|----------------|----|----------------------|
| 12       | 1PCER-8M       | 80 | W = 5,00<br>P = 5,00 |

# Carbide Die Inserts with Full Length Taper

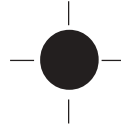
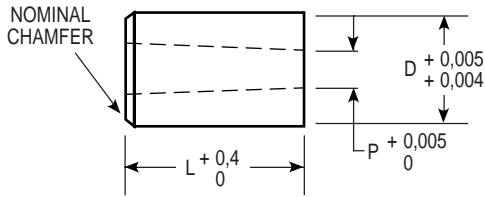

**ROUND**

CONCENTRICITY O.D. AND I.D., 0,005 T.I.R.  
\* TAPER IN "P" 0° - 9' PER SIDE

| CATALOG NUMBER | D BODY DIAMETER | P INSIDE DIAMETER | L = LENGTH |    |
|----------------|-----------------|-------------------|------------|----|
|                |                 |                   | 25         | 32 |
| 1DT-4M         | 4,0             | 0,75 - 2,00       | •          | •  |
| 1DT-5M         | 5,0             | 0,75 - 2,50       | •          | •  |
| 1DT-6M         | 6,0             | 0,75 - 3,50       | •          | •  |
| 1DT-8M         | 8,0             | 0,75 - 5,25       | •          | •  |



NOTE: ANY DIMENSION OTHER THAN THOSE SHOWN QUOTED ON REQUEST

**WHEN ORDERING SPECIFY:**

| Quantity | Catalog Number | L  | P    |
|----------|----------------|----|------|
| 3        | 1DT-8M         | 25 | 4,00 |

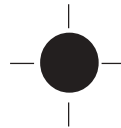
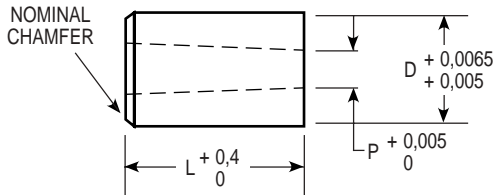

**ROUND**

CONCENTRICITY O.D. AND I.D., 0,005 T.I.R.  
\* TAPER IN "P" 0° - 9' PER SIDE

| CATALOG NUMBER | D BODY DIAMETER | P INSIDE DIAMETER | L = LENGTH |    |
|----------------|-----------------|-------------------|------------|----|
|                |                 |                   | 25         | 32 |
| 1DT-10M        | 10,0            | 4,00 - 7,00       | •          | •  |
| 1DT-13M        | 13,0            | 4,00 - 8,50       | •          | •  |
| 1DT-16M        | 16,0            | 6,50 - 10,00      | •          | •  |
| 1DT-20M        | 20,0            | 9,50 - 14,00      | •          | •  |
| 1DT-25M        | 25,0            | 9,50 - 17,50      | •          | •  |

NOTE: ANY DIMENSION OTHER THAN THOSE SHOWN QUOTED ON REQUEST

**WHEN ORDERING SPECIFY:**

| Quantity | Catalog Number | L  | P     |
|----------|----------------|----|-------|
| 2        | 1DT-20M        | 32 | 10,00 |

# Carbide Die Inserts with Full Length Taper and Machinable Steel Sleeve Head

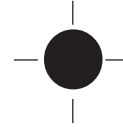
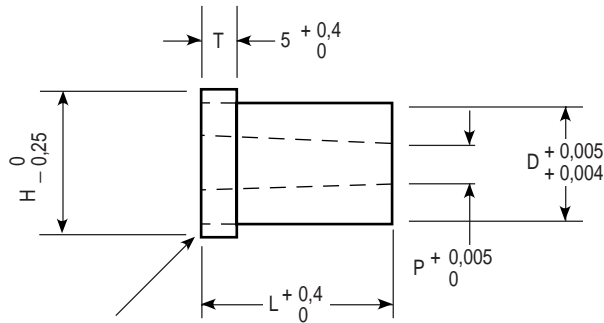

**ROUND**

CONCENTRICITY O.D. AND I.D., 0,005 T.I.R.  
\* TAPER IN "P" 0° - 9° PER SIDE

| CATALOG NUMBER | D BODY DIAMETER | P INSIDE DIAMETER | H HEAD DIAMETER | L = LENGTH |    |
|----------------|-----------------|-------------------|-----------------|------------|----|
|                |                 |                   |                 | 25         | 32 |
| 1DTS-4M        | 4,0             | 0,75 - 2,00       | 7,00            | •          | •  |
| 1DTS-5M        | 5,0             | 0,75 - 2,50       | 8,00            | •          | •  |
| 1DTS-6M        | 6,0             | 0,75 - 3,50       | 9,00            | •          | •  |
| 1DTS-8M        | 8,0             | 0,75 - 5,25       | 11,00           | •          | •  |



NOTE: ANY DIMENSION OTHER THAN THOSE SHOWN QUOTED ON REQUEST

**WHEN ORDERING SPECIFY:**

| Quantity | Catalog Number | L  | P    |
|----------|----------------|----|------|
| 2        | 1DTS-8M        | 25 | 4,50 |

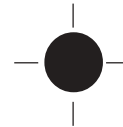
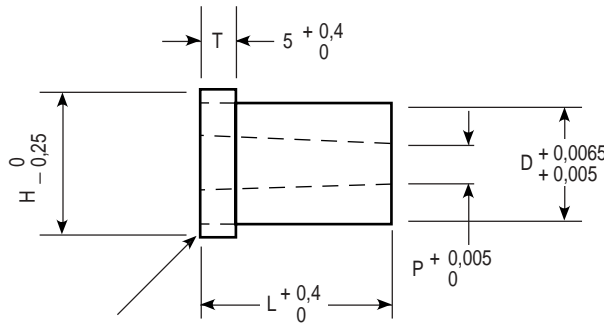

**ROUND**

CONCENTRICITY O.D. AND I.D., 0,005 T.I.R.  
\* TAPER IN "P" 0° - 9° PER SIDE

| CATALOG NUMBER | D BODY DIAMETER | P INSIDE DIAMETER | H HEAD DIAMETER | L = LENGTH |    |
|----------------|-----------------|-------------------|-----------------|------------|----|
|                |                 |                   |                 | 25         | 32 |
| 1DTS-10M       | 10,0            | 4,00 - 7,00       | 13,00           | •          | •  |
| 1DTS-13M       | 13,0            | 4,00 - 8,50       | 16,00           | •          | •  |
| 1DTS-16M       | 16,0            | 6,50 - 10,00      | 19,00           | •          | •  |
| 1DTS-20M       | 20,0            | 9,50 - 14,00      | 23,00           | •          | •  |
| 1DTS-25M       | 25,0            | 9,50 - 17,50      | 28,00           | •          | •  |

NOTE: ANY DIMENSION OTHER THAN THOSE SHOWN QUOTED ON REQUEST

**WHEN ORDERING SPECIFY:**

| Quantity | Catalog Number | L  | P     |
|----------|----------------|----|-------|
| 3        | 1DTS-25M       | 32 | 16,12 |

# Carbide Die Inserts with Counterbore

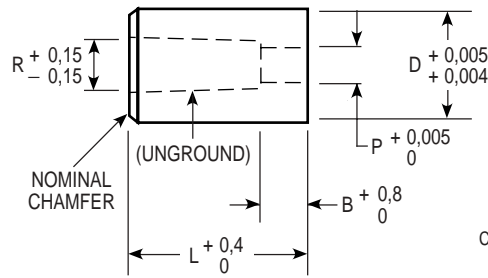

CONCENTRICITY O.D. AND I.D., 0,005 T.I.R.  
\* TAPER IN "P" 0° - 9° PER SIDE

| CATALOG NUMBER | D BODY DIAMETER | P INSIDE DIAMETER | R RELIEF DIAMETER | B LAND | L = LENGTH |    |
|----------------|-----------------|-------------------|-------------------|--------|------------|----|
|                |                 |                   |                   |        | 25         | 32 |
| 1DC-6M         | 6,0             | 2,34 - 2,75       | 3,2               | 5,0    | •          | •  |
| 2DC-6M         | 6,0             | 2,76 - 3,15       | 3,7               | 5,0    | •          | •  |
| 3DC-6M         | 6,0             | 3,16 - 3,56       | 4,0               | 6,4    | •          | •  |
| 1DC-8M         | 8,0             | 2,34 - 2,75       | 3,2               | 5,0    | •          | •  |
| 2DC-8M         | 8,0             | 2,76 - 3,15       | 3,7               | 5,0    | •          | •  |
| 3DC-8M         | 8,0             | 3,16 - 3,56       | 4,0               | 6,4    | •          | •  |
| 4DC-8M         | 8,0             | 3,57 - 4,58       | 5,3               | 6,4    | •          | •  |
| 5DC-8M         | 8,0             | 4,59 - 4,96       | 5,6               | 6,4    | •          | •  |



NOTE: ANY DIMENSION OTHER THAN THOSE SHOWN QUOTED ON REQUEST

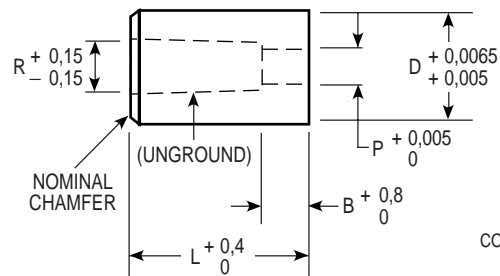

CONCENTRICITY O.D. AND I.D., 0,005 T.I.R.  
\* TAPER IN "P" 0° - 9° PER SIDE

| CATALOG NUMBER | D BODY DIAMETER | P INSIDE DIAMETER | R RELIEF DIAMETER | B LAND | L = LENGTH |    |
|----------------|-----------------|-------------------|-------------------|--------|------------|----|
|                |                 |                   |                   |        | 25         | 32 |
| 1DC-10M        | 10,0            | 3,95 - 5,70       | P + 0,4           | 10,0   | •          | •  |
| 1DC-13M        | 13,0            | 3,95 - 7,60       | P + 0,4           | 10,0   | •          | •  |
| 1DC-16M        | 16,0            | 6,60 - 10,00      | P + 0,4           | 10,0   | •          | •  |
| 1DC-20M        | 20,0            | 9,50 - 13,85      | P + 0,4           | 10,0   | •          | •  |
| 1DC-25M        | 25,0            | 9,50 - 17,50      | P + 0,4           | 10,0   | •          | •  |

NOTE: ANY DIMENSION OTHER THAN THOSE SHOWN QUOTED ON REQUEST

**WHEN ORDERING SPECIFY:**

| Quantity | Catalog Number | L  | P    |
|----------|----------------|----|------|
| 6        | 4DC-8M         | 25 | 4,00 |

# Carbide Die Inserts with Counterbore and Machinable Steel Sleeve Head

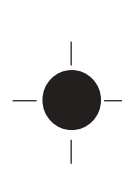
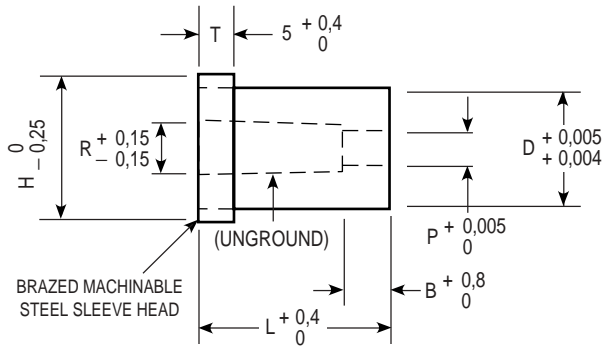

CONCENTRICITY O.D. AND I.D., 0,005 T.I.R.  
\* TAPER IN 'P' 0° - 9' PER SIDE

| CATALOG NUMBER | D BODY DIAMETER | P INSIDE DIAMETER | R RELIEF DIAMETER | B LAND | H HEAD DIAMETER | L = LENGTH |    |
|----------------|-----------------|-------------------|-------------------|--------|-----------------|------------|----|
|                |                 |                   |                   |        |                 | 25         | 32 |
| 1DCS-6M        | 6,0             | 2,34 - 2,75       | 3,2               | 5,0    | 9,00            | •          | •  |
| 2DCS-6M        | 6,0             | 2,76 - 3,15       | 3,7               | 5,0    | 9,00            | •          | •  |
| 3DCS-6M        | 6,0             | 3,16 - 3,56       | 4,0               | 6,4    | 9,00            | •          | •  |
| 1DCS-8M        | 8,0             | 2,34 - 2,75       | 3,2               | 5,0    | 11,00           | •          | •  |
| 2DCS-8M        | 8,0             | 2,76 - 3,15       | 3,7               | 5,0    | 11,00           | •          | •  |
| 3DCS-8M        | 8,0             | 3,16 - 3,56       | 4,0               | 6,4    | 11,00           | •          | •  |
| 4DCS-8M        | 8,0             | 3,57 - 4,58       | 5,3               | 6,4    | 11,00           | •          | •  |
| 5DCS-8M        | 8,0             | 4,59 - 4,96       | 5,6               | 6,4    | 11,00           | •          | •  |



NOTE: ANY DIMENSION OTHER THAN THOSE SHOWN QUOTED ON REQUEST

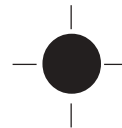
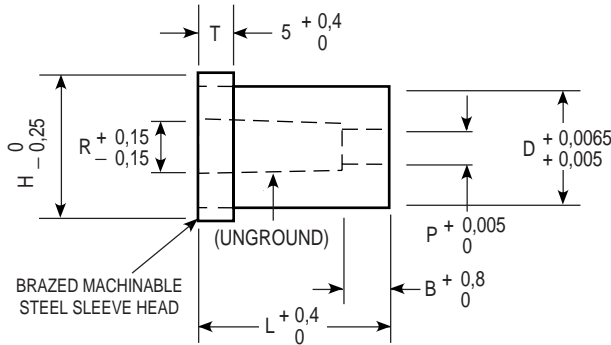

CONCENTRICITY O.D. AND I.D., 0,005 T.I.R.  
\* TAPER IN 'P' 0° - 9' PER SIDE

| CATALOG NUMBER | D BODY DIAMETER | P INSIDE DIAMETER | R RELIEF DIAMETER | B LAND | H HEAD DIAMETER | L = LENGTH |    |
|----------------|-----------------|-------------------|-------------------|--------|-----------------|------------|----|
|                |                 |                   |                   |        |                 | 25         | 32 |
| 1DCS-10M       | 10,0            | 3,95 - 5,70       | P + 0,4           | 10,0   | 13,00           | •          | •  |
| 1DCS-13M       | 13,0            | 3,95 - 7,60       | P + 0,4           | 10,0   | 16,00           | •          | •  |
| 1DCS-16M       | 16,0            | 6,60 - 10,00      | P + 0,4           | 10,0   | 19,00           | •          | •  |
| 1DCS-20M       | 20,0            | 9,50 - 13,85      | P + 0,4           | 10,0   | 23,00           | •          | •  |
| 1DCS-25M       | 25,0            | 9,50 - 17,50      | P + 0,4           | 10,0   | 28,00           | •          | •  |

NOTE: ANY DIMENSION OTHER THAN THOSE SHOWN QUOTED ON REQUEST

**WHEN ORDERING SPECIFY:**

| Quantity | Catalog Number | L  | P    |
|----------|----------------|----|------|
| 6        | 1DCS-13M       | 32 | 6,40 |

# Carbide Die Inserts, Wire EDM Blanks With Starter Hole

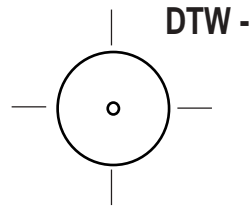
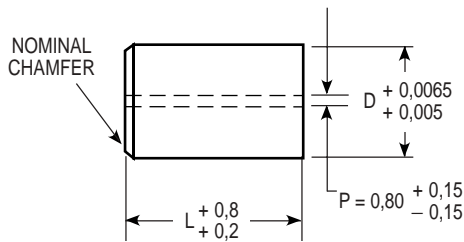

| CATALOG NUMBER | D BODY DIAMETER | L = LENGTH |    |
|----------------|-----------------|------------|----|
|                |                 | 25         | 32 |
| 1DTW-5M        | 5,0             | •          | •  |
| 1DTW-6M        | 6,0             | •          | •  |
| 1DTW-8M        | 8,0             | •          | •  |
| 1DTW-10M       | 10,0            | •          | •  |
| 1DTW-13M       | 13,0            | •          | •  |
| 1DTW-16M       | 16,0            | •          | •  |
| 1DTW-20M       | 20,0            | •          | •  |
| 1DTW-25M       | 25,0            | •          | •  |

NOTE: ANY DIMENSION OTHER THAN THOSE SHOWN QUOTED ON REQUEST

**WHEN ORDERING SPECIFY:**

| Quantity | Catalog Number | L  |
|----------|----------------|----|
| 4        | 1DTW-8M        | 25 |

**BRAZED MACHINABLE STEEL SLEEVE HEAD AVAILABLE**



Please specify locating devices by the following designations:

DS = Dowel Slot = 3,0

F1 = Single Flat  $\left(\frac{D}{2} - 1,5\right)$

F2 = Double Flat  $\left(\frac{D}{2} - 1,5\right)$

All locating devices will be parallel to the longest dimension.

Special locations or devices will be furnished if fully dimensioned print is provided.

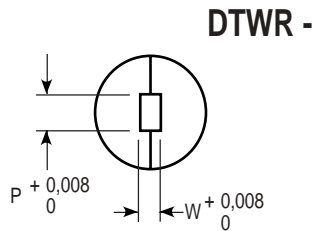

**RECTANGLE  
(Including Square)**

INTERNAL TAPER 0° 9' PER SIDE\*  
CORNER RADIUS = 0,18  
CONCENTRICITY O.D. AND I.D. 0,009 T.I.R.

**WHEN ORDERING SPECIFY:**

| Quantity | Catalog Number | L  | Hole Size |     | Locating Device |
|----------|----------------|----|-----------|-----|-----------------|
|          |                |    | W         | P   |                 |
| 26       | 1DTWR-8M       | 32 | 2,0       | 4,0 | F1              |

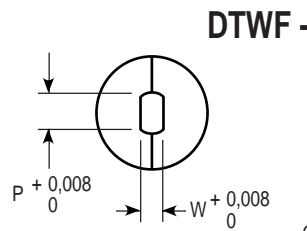

**FLATTED ROUND**

INTERNAL TAPER 0° 9' PER SIDE\*  
CORNER RADIUS = 0,18  
CONCENTRICITY O.D. AND I.D. 0,009 T.I.R.

**WHEN ORDERING SPECIFY:**

| Quantity | Catalog Number | L  | Hole Size |     | Locating Device |
|----------|----------------|----|-----------|-----|-----------------|
|          |                |    | W         | P   |                 |
| 18       | 1DTWF-8M       | 32 | 2,0       | 4,0 | F1              |

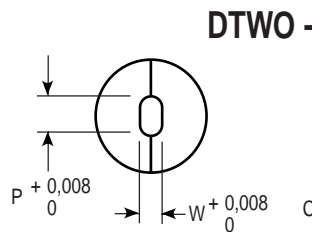

**OBLONG**

INTERNAL TAPER 0° 9' PER SIDE\*  
CONCENTRICITY O.D. AND I.D. 0,009 T.I.R.

**WHEN ORDERING SPECIFY:**

| Quantity | Catalog Number | L  | Hole Size |     | Locating Device |
|----------|----------------|----|-----------|-----|-----------------|
|          |                |    | W         | P   |                 |
| 18       | 1DTWO-8M       | 32 | 2,0       | 4,0 | F1              |

# Carbide Die Inserts, Half Rounds

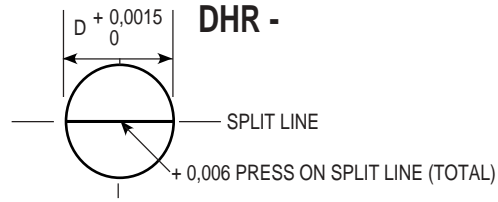
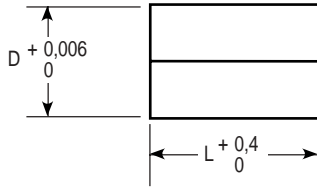

**WHEN ORDERING SPECIFY:**

| CATALOG NUMBER | D BODY DIAMETER | L = LENGTH |    |
|----------------|-----------------|------------|----|
|                |                 | 25         | 32 |
| 1DHR-6M        | 6,0             | •          | •  |
| 1DHR-8M        | 8,0             | •          | •  |
| 1DHR-10M       | 10,0            | •          | •  |
| 1DHR-13M       | 13,0            | •          | •  |
| 1DHR-16M       | 16,0            | •          | •  |
| 1DHR-20M       | 20,0            | •          | •  |
| 1DHR-25M       | 25,0            | •          | •  |

| Quantity | Catalog Number | L  |
|----------|----------------|----|
| 8        | 1DHR-8M        | 32 |

The press fit across the split is slightly larger than normal to prevent separation during operation

NOTE: ANY DIMENSION OTHER THAN THOSE SHOWN QUOTED ON REQUEST

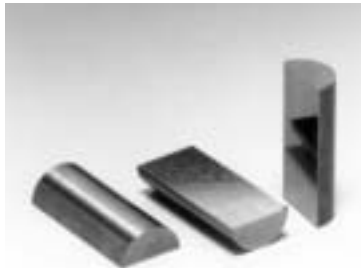

Please specify locating devices by the following designations:

DS = Dowel Slot = 3,0

F1 = Single Flat  $\left(\frac{D}{2} - 1,5\right)$

F2 = Double Flat  $\left(\frac{D}{2} - 1,5\right)$

All locating devices will be parallel to the longest dimension.

Special locations or devices will be furnished if fully dimensioned print is provided.

**DHRR -**

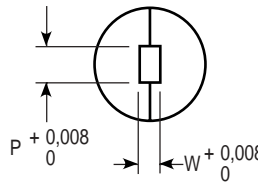

**RECTANGLE  
(Including Square)**

INTERNAL TAPER  $0^{\circ} 9'$  PER SIDE\*  
CORNER RADIUS = 0,127  
CONCENTRICITY O.D. AND I.D. 0,009 T.I.R.

**WHEN ORDERING SPECIFY:**

| Quantity | Catalog Number | L  | Hole Size |     | Locating Device |
|----------|----------------|----|-----------|-----|-----------------|
|          |                |    | W         | P   |                 |
| 26       | 1DHRR-8M       | 32 | 2,0       | 4,0 | F1              |

**DHRF -**

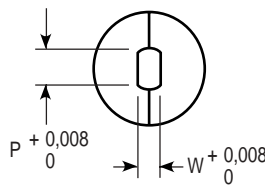

**FLATTED ROUND**

INTERNAL TAPER  $0^{\circ} 9'$  PER SIDE\*  
CORNER RADIUS = 0,127  
CONCENTRICITY O.D. AND I.D. 0,009 T.I.R.

**WHEN ORDERING SPECIFY:**

| Quantity | Catalog Number | L  | Hole Size |     | Locating Device |
|----------|----------------|----|-----------|-----|-----------------|
|          |                |    | W         | P   |                 |
| 18       | 1DHRF-8M       | 32 | 2,0       | 4,0 | F1              |

**DHRO -**

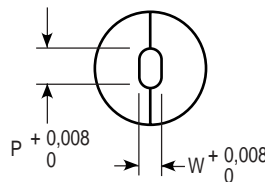

**OBLONG**

INTERNAL TAPER  $0^{\circ} 9'$  PER SIDE\*  
CONCENTRICITY O.D. AND I.D. 0,009 T.I.R.

**WHEN ORDERING SPECIFY:**

| Quantity | Catalog Number | L  | Hole Size |     | Locating Device |
|----------|----------------|----|-----------|-----|-----------------|
|          |                |    | W         | P   |                 |
| 18       | 1DHRO-8M       | 32 | 2,0       | 4,0 | F1              |

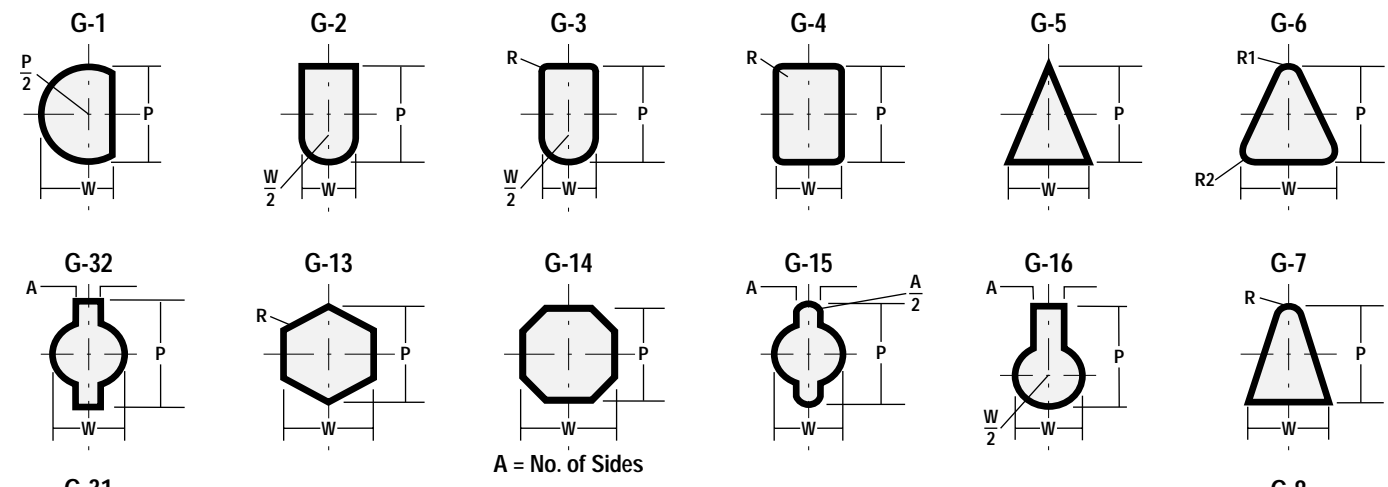

A = No. of Sides

***Special Shapes***

Our customers have requirements for punches and inserts with special shapes or configurations. We have manufactured literally hundreds of these special shaped components for companies all over the world. Those shown on this page represent only a random sampling. We'd like to quote on your next "special." For any shape not listed, send us your fully dimensioned print and we'll send you a quotation.

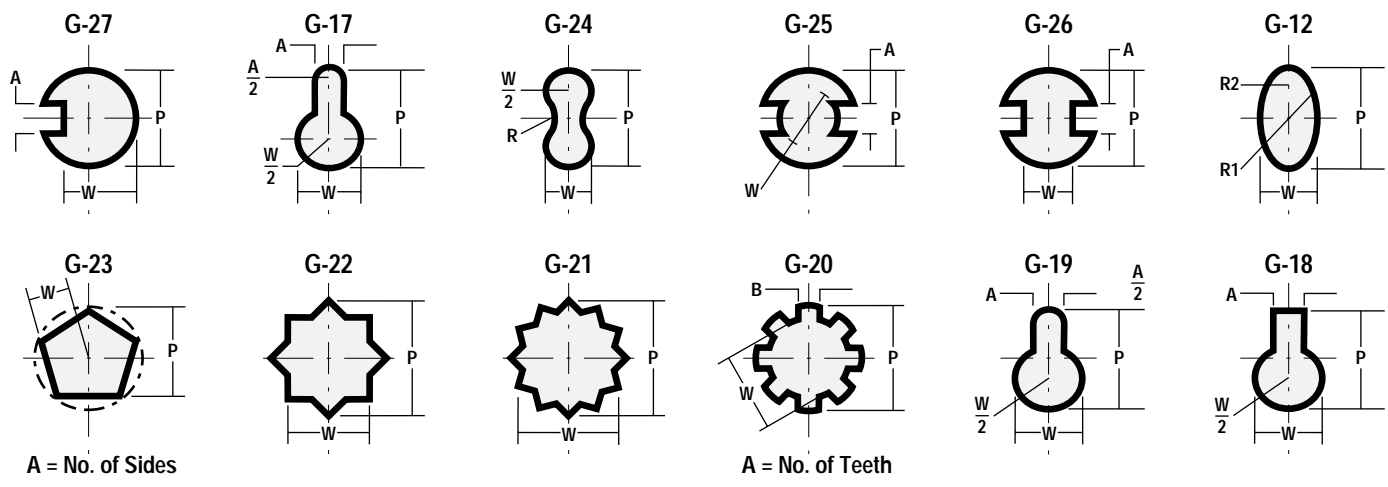
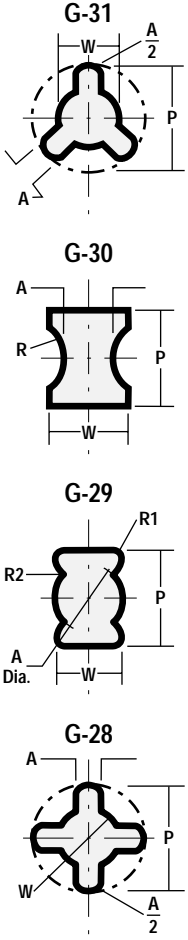

A = No. of Sides

A = No. of Teeth

# Locating Devices

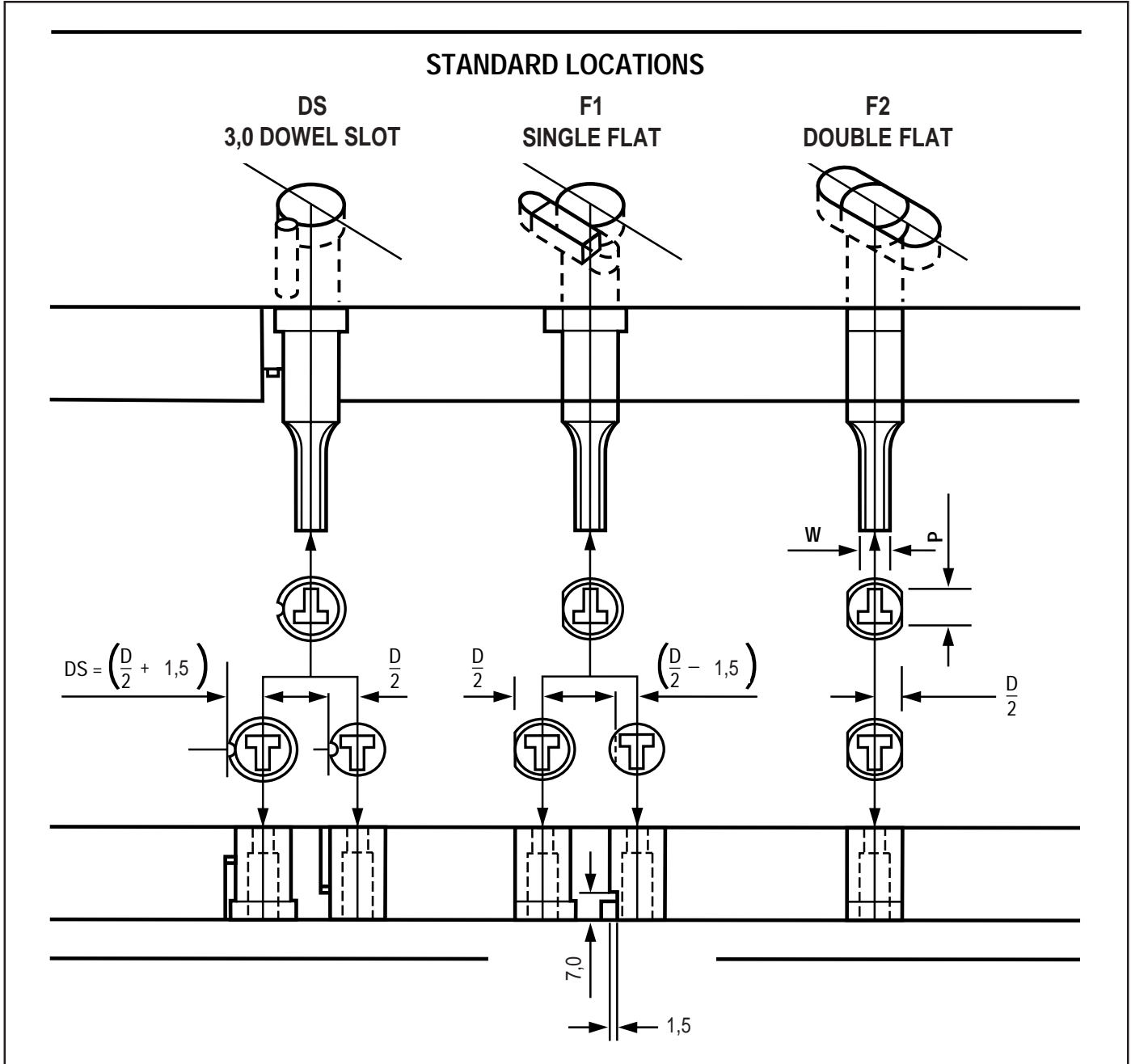

**STANDARD LOCATIONS**

Standard dowel and key locations are located parallel to the longest dimension ("P") for positive alignment.

**HOW TO ORDER**

Use code — DS, F1, or F2 after item ordered.

Please specify locating devices by the following designations:

DS = Dowel Slot = 3,0

F1 = Single Flat  $\left(\frac{D}{2} - 1,5\right)$

F2 = Double Flat  $\left(\frac{D}{2} - 1,5\right)$

All locating devices will be parallel to the longest dimension.

Special locations or devices will be furnished if fully dimensioned print is provided.

# Oberg Precision Tooling

---

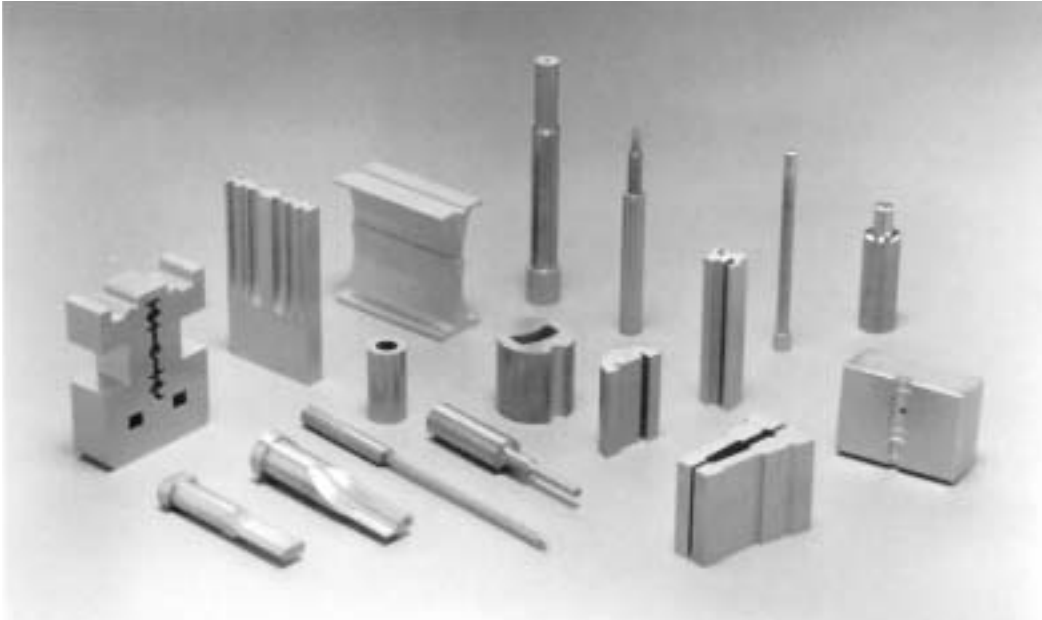

Oberg Industries manufactures carbide die components specifically to your print or drawing, regardless of shape or size. In many instances your special die components can be either precision ground or manufactured utilizing traveling wire electrical discharge machining (EDM).

Since 1948 Oberg Industries has been recognized as the world's leading manufacturer of precision carbide stamping die components, tooling and carbide wear parts. We specialize in the design and build of precision dies to make both flat and formed parts, especially those producing one or multiple parts with each press stroke.

With the finest manufacturing facilities and equipment, operated by the best trained craftsmen available, we've committed ourselves to maintaining our industry leadership position well into the 21st Century.